



KABA®

Auditcon® 2 Series Commercial Safe Locks

Models 52/T52/252/552



The Auditcon Legacy

The Auditcon® family of electronic locks was developed to address the security requirements of a broad range of retail, commercial and industrial markets. Utilizing the award-winning PowerStar™ technology, the Auditcon's security cannot be compromised by outside manipulation and provides unprecedented audit capability, making it an effective deterrent to internal theft.

Auditcon 2 Features and Benefits

Auditcon 2 Series locks are the new standard in safe lock security. With improved serviceability, faster power-up, and uploadable programming, the Auditcon 2 Series locks will make securing your valuables easier than ever.

Improved Self-Powered Technology

Auditcon 2 Series locks utilize a faster version of our PowerStar technology. This technology eliminates lockouts due to dead batteries or facility power failures.

Battery Assist

The Battery Assist option uses a 9-volt alkaline battery to supply power during Time Delay or Open Window operations.

The Battery Assist feature also provides additional power for lengthy lock operations.

Uploadable Programming

Certain data can be defined at the PC using Auditcon 2 Series software and then uploaded (transferred) to the lock via a Smart Key.

Access Control

Models 52 & T52 have a unique user-selected 6-digit combination. Models 252 and 552 have an 8-digit combination which includes a 2-digit user ID and a 6-digit user-selected PIN.

Audit Trail (252/552)

The user's ID is recorded every time a function is performed on the lock, deterring internal theft by providing absolute reliability.

Touch Key Number Pad

Perform all functions and programming of the lock from the keypad.

Wrong Try Lock-out

Five consecutive wrong combination entries triggers a three minute penalty lockout.

Economical Retrofit

Simple and affordable retrofitting made possible by a standard footprint lock case.

Time Delay (T52/252/552)

Optionally programmed 1-99 minute time delay deters potential intruders not willing to risk the wait.

Time Delay Display (T52/252/552)

An optionally purchased LCD Unit prominently displays the time, informing the user when access will be granted.

Dual Mode

Optionally programmed mode that provides absolute accountability by requiring the entry of two separate user combinations when opening the lock.

Silent Duress Alarm Connection (252/552)

Safely lets employees comply with intruder's demands while alerting authorities.

Time Saving Operation

Mechanical combination locks can take as much as 40 seconds or longer to open. Auditcon 2 Series locks can be opened in just a few seconds by an authorized user.

Choice of Bolt

The "slide bolt" and the "swing bolt" automatically lock when the safe handle is closed. The standard "dead bolt" functions like a traditional dial lock with manual bolt retraction/extension.

Installation & Service

Installation and service have been simplified with the introduction of a new field-replaceable cable with Picoflex connector. Our Auditcon Parts Program will help you identify and order only the parts you need.

Customer Service

The Kaba Mas technical support staff is available 24 hours a day, seven days a week to answer any technical questions you may have. Please call us at 800-950-4744.

Education

We take pride in providing regular training classes for our customers. Please call us at 877-KabaMas (877-522-2627) for more information.

Applications

Businesses that require multiple employee access, have several locations, absentee ownership or high employee turnover, are ideal for Auditcon locks. Auditcon can secure safes, containers, vaults and restricted areas for:

- Restaurants
- Ticket box offices
- Convenience stores
- Grocery stores
- Department stores
- Drug stores
- Jewelry stores
- Banks & credit unions
- Hospitals
- Police stations
- Data processing centers
- Casinos

AVAILABLE MODELS



Round 52/T52

Vertical 52/T52

Round 252/552

Vertical 252/552

| | 52/T52 | 252 | 552 |
|-----------------------------|--|------------------------------------|------------------------------------|
| Keypad Housing Styles | Round/Vertical | Round/Vertical | Round/Vertical |
| Bolt Styles | Dead, Slide or Swing Bolt | Dead, Slide or Swing Bolt | Dead, Slide or Swing Bolt |
| Users | 2 Users | 20 Users | 99 Users |
| Combination Length | 6-Digit | 8-Digit | 8-Digit |
| Power Source | Self-Powered | Self-Powered | Self-Powered |
| Battery Assist | Optional (T52) | Optional | Required |
| Manager/Master Control | Yes (Manager) | Yes (Master) | Yes (Master) |
| Supervisor/Subordinate Mode | No | Yes | Yes |
| Single/Dual Custody Access | Yes | Yes | Yes |
| Wrong Try Lockout | Yes | Yes | Yes |
| Time Delay/Open Window | 1-99 Min Delay (T52) 1-20 Min Opening (T52) | 1-99 Min Delay 1-20 Min Opening | 1-99 Min Delay 1-20 Min Opening |
| Time Delay Override | No | Yes | Yes |
| Time Delay Display | Optional (T52) | Optional | Optional |
| Time and Date | No | No | Yes |
| Timed Lockout | No | No | Yes (1-255 Hrs) |
| Time Windows | No | No | Yes |
| Time Window Lockout | No | No | Yes |
| Set Holidays | No | No | Yes |
| Uploadable Programming* | No | Yes | Yes |
| Downloadable Audit Trail* | No | 100 Audits | 400 Audits |

*Requires optionally purchased Auditcon 2 Series Software Package.

Specifications

Agency Approvals

- UL Type I high security electronic locks
- DNV High Security (Sweden, Denmark, Norway, Finland), VdS Class 2 (Germany), CE, EN 1300 Class B (EU)

ELECTRONIC SPECIFICATIONS

Power Unit: Solenoid driven.

Power Source: PowerStar™ technology - Internal generator creates power when dial is rotated. No battery necessary.

Battery Assist: One 9-Volt Alkaline (not included). Featured during Time Delay and Open Window periods. Also provides additional power during lengthy operations.

Memory: Programmable, non-volatile EEPROM.

ENVIRONMENTAL SPECIFICATIONS

Temperature: -31° F (-35° C) to 151° F (+66° C)

Humidity: 86°F (30°C) and 85% relative humidity for 24 hours

Salt Spray: Operational after 24 hours

Mechanical Specifications

Lock Case: 2-piece lock case (cover & box), solid cast zinc, flash and chromate conversion coat for corrosion resistance. Tested to 25,000 cycles. Designed to meet industry standard container lock mounting pattern. Mounting screws included. Bolts, housings, cables, spindles and options must be specified. See Kaba Mas List Price Book for options.

Housing: UV stabilized polycarbonate. Available: Round or Vertical.

Keypad: Silicone rubber, 12-button tactile keypad, red and green LEDs reinforced with an audible signal (beep) for communications, and Kaba logo face. Plain face also available.

Bolt: Dead bolt is non-magnetic stainless steel with a manual return. Slide bolt and swing bolt options are also available. See Kaba Mas List Price Book.

Relocker Plate: Universal relocker that fits most major safe manufacturer applications furnished standard. Other relockers available. See Kaba Mas List Price Book for options.

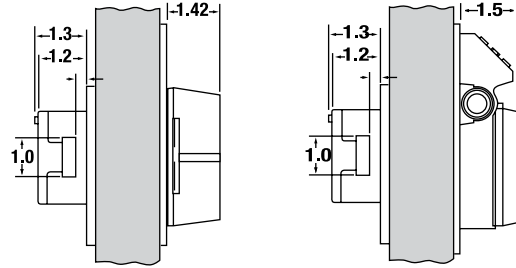

Round and Vertical Depth Dimensions

Door Preparation

Lock is designed to fit industry standard mounting pattern.

Door Thickness: Refer to Kaba Mas List Price Book for options.

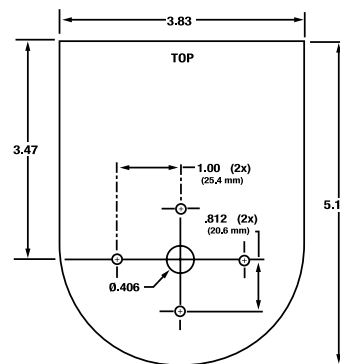

NOTE: Full-scale templates provided at www.kaba-mas.com.

Vertical Housing

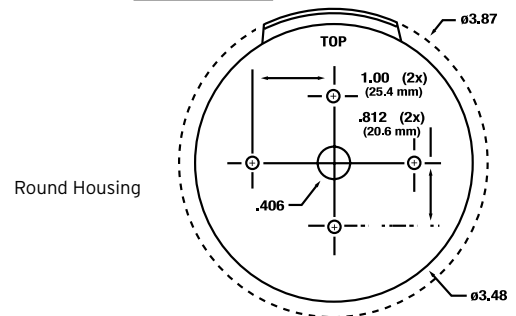

Round Housing

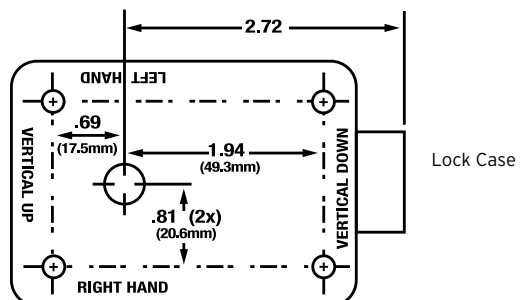

Lock Case

Model 52/T52 Features

2 users • 6-digit access combination • Faster power-up • Replaces mechanical Group I & Group II locks • Wrong try lockout • Dead bolt, slide bolt and swing bolt available • UL listed, Type I high security electronic locks • DNV, VdS Class 2, CE and EN 1300 Class B certification

Numerical Keypad: Quick Entry.

Wrong Try Lockout: The lock will not allow access to any user for a period of 3 minutes after 5 incorrect combinations are entered. Any additional consecutive failed entry attempts result in another 3 minute lockout.

Easy Retrofit: The lock case has the same footprint as most mechanical locks making it easy to install.

Users: Two users.

6-Digit Access Combination: Users select their own changeable combination.

Additional Security Features

Dual Custody: Two-Person Integrity, which requires two users to open the lock.

Manager/User Operation: Allows manager to add, delete, enable or disable an additional user.

Time Delay (Model T52): Programmable 1-99 minutes before access is allowed. NOTE: Remote Time Delay Display Unit (p/n 307025) can be purchased separately. Please refer to the Kaba Mas List Price Book for options.

Model 52 Ordering Example

Model 52 lock with PowerStar (self-powered) technology, vertical housing, non-time delay display compatibility, dead bolt, non-sensor, no relocker plate, up to 1" door/cable measurement, English country classification, Kaba dial label, standard installation screws and individually packed.

For a complete list of options, refer to the Kaba Mas List Price Book.



| | | | | | | | | | | | | | | | |
|---------|--------------------|---|---|---|-----------------|---|------|---|---|---------------------|-------------------|--------------|------------|---------|-----------|
| EXAMPLE | 0 | 5 | 2 | S | V | N | 1 | 0 | N | 4 | A | E | A | 1 | A |
| | Model Power Source | | | | Housing Display | | Bolt | | | Relocker Case Cover | Door Cable Msrmt. | Country Code | Dial Label | Install | Packaging |

Model 252 Features

20 users • 8-digit access combination • Faster power-up • Replaces mechanical Group I & Group II locks • Wrong try lockout • Dead bolt, slide bolt and swing bolt available • UL listed, Type I high security electronic locks • DNV, VdS Class 2, CE and EN 1300 Class B certification

Numerical Keypad: Quick Entry.

Wrong Try Lockout: The lock will not allow access to any user for a period of 3 minutes after 5 incorrect combinations are entered. Any additional consecutive failed entry attempts result in another 3 minute lockout.

Easy Retrofit: The lock has the same footprint as most mechanical locks making it easy to install.

Users: Up to 20 users.

8-Digit Access Combination: Users have an 8 digit combination which includes a 2-digit user ID and a 6-digit user selected PIN.

Audit Trail: Number of entries/activities is 100 records in sequential order.

Available PC Software: Print, display or file the lock audit reports using a program which runs under Microsoft Windows® Software.

- Program Lock Setup Options
- Add/Delete Users
- Audit Download Reports
- User Table Download Reports

Supervisor/Subordinate Mode: Allows access by a subordinate only after being enabled by a supervisory combination. Once enabled, a subordinate user has access to the lock during any valid opening time.

Additional Security Features

Dual Custody: Two-Person Integrity, which requires two users to open the lock.

Alarm Interface: (Optional) Activates the lock's duress condition, sending a silent alarm, when combined with a connection to an existing alarm system.

Time Delay: Programmable 1-99 minutes before access is allowed. NOTE: Remote Time Delay Display Unit (p/n 307025) can be purchased separately. Please refer to the Kaba Mas List Price Book for options.

Model 252 Ordering Example

Model 252 lock with PowerStar (self-powered) technology, vertical housing, non-time delay display compatibility, dead bolt, non-sensor, no relocker plate, up to 1" door/cable measurement, English country classification, Kaba dial label, standard installation screws and individually packed.

For a complete list of options, refer to the Kaba Mas List Price Book.



| | | | | | | | | | | | | | | | |
|---------|-----------------------|---|---|---|--------------------|---|------|---|---|------------------------|--------------------------|-----------------|---------------|---------|-----------|
| EXAMPLE | 2 | 5 | 2 | S | V | N | 1 | 0 | N | 4 | A | E | A | 1 | A |
| | Model Power Source | | | | Housing Display | | Bolt | | | Relocker Case Cover | Door Cable Msrmnt. | Country Code | Dial Label | Install | Packaging |

Model 552 Features

99 users/400 record audit • 8-digit access combination • Faster power-up • Replaces mechanical Group I & Group II locks • Wrong try lockout • Dead bolt, slide bolt and swing bolt available • UL listed, Type I high security electronic locks • DNV, VdS Class 2, CE and EN 1300 • Class B certification

Numerical Keypad: Quick Entry.

Wrong Try Lockout: The lock will not allow access to any user for a period of 3 minutes after 5 incorrect combinations are entered. Any additional consecutive failed entry attempts result in another 3 minute lockout.

Easy Retrofit: The lock has the same footprint as most mechanical locks making it easy to install.

Users: Up to 99 users.

8-Digit Access Combination: Users have an 8-digit combination which includes a 2-digit user ID and a 6-digit user selected PIN.

Audit Trail: Number of entries/activities is 400 records in sequential order.

Battery Assist: Lock LEDs will continually flash throughout the duration of a Time Delay or Open Window period. Also provides additional power for lengthy operations.

Available PC Software: Print, display or file the lock audit reports using a program which runs under Microsoft Windows® Software.

- Program Lock Setup Options
- Upload Lock Time/Date
- Add/Delete Users
- Upload Time Windows
- Audit Download Reports
- User Table Download Reports

Supervisor/Subordinate Mode: Allows access by a subordinate only after being enabled by a supervisory combination. Once enabled, a subordinate user has access to the lock during any valid opening time.

Additional Security Features

Dual Custody: Two-Person Integrity, which requires two users to open the lock.

Time Delay: Programmable 1-99 minutes before access is allowed. NOTE: Remote Time Delay Display Unit (p/n 307025) can be purchased separately. Please refer to the Kaba Mas List Price Book for options.

Alarm Interface: (Optional) Activates the lock's duress condition, sending a silent alarm, when combined with a connection to an existing alarm system.





Time & Date Stamp on Audit: Internal battery chip allows for real time date and time in audit.

Timed Lockout: Enables certain users to disable lock access for a period of 1-255 hours. Once Timed Lockout begins, the lock will not accept any commands.

Time Windows: Allows Master User to define time windows for access to the lock. Note: Battery Assist is recommended when implementing this feature manually at the lock.

Time Window Lockout: Enables certain users to disable lock access for the current open time window. Lock entry remains disabled until the time of the next open time window as defined by the Time Windows function.

Set Holidays: Enables the Master User to define up to 20 annual holidays in the lock. Note: This feature requires Battery Assist.

Model 552 Ordering Example

Model 552 lock with PowerStar (self-powered) technology with Battery Assist, vertical housing, non-time delay display compatibility, dead bolt, non-sensor, no relocker plate, up to 1" door/cable measurement, English country classification, Kaba dial label, standard installation screws and individually packed. **For a complete list of options, refer to the Kaba Mas List Price Book.**

| | | | | | | | | | | | | | | | |
|---------|--------------------|---|---|---|-----------------|---|------|---|---|---------------------|-------------------|--------------|------------|---------|-----------|
| EXAMPLE | 5 | 5 | 2 | A | V | N | 1 | O | N | 4 | A | E | A | 1 | A |
| | Model Power Source | | | | Housing Display | | Bolt | | | Relocker Case Cover | Door Cable Msrmt. | Country Code | Dial Label | Install | Packaging |

Options & Accessories

BOLT OPTIONS

Kaba Mas offers a variety of locking bolts to meet most container applications.

Dead Bolt

The square “no hole bolt” is furnished standard. for a spindled application.

Slide Bolt & Swing Bolt

Slide bolts and swing bolts do not require use of a spindle. They operate in conjunction with the container bolt works which increases security and simplifies installation. Slide bolts are not VdS approved.

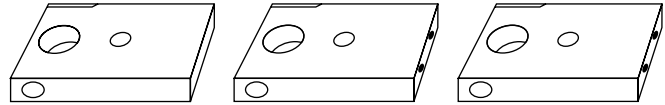

Dead bolt, non-sensor (#10N) standard Dead bolt, sensor (#10Y)

Dead bolt, non-sensor 10-32.5 (2X) tapped holes (#20N)

Dead bolt, non-sensor M4-7 x 15mm (2X) tapped holes (#23N)

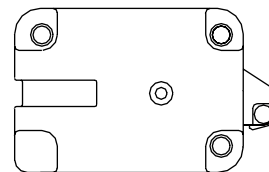

Slide bolt, non-sensor (#70N)
Non-VdS approved.

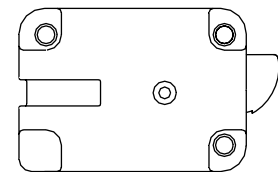

Swing bolt, non-sensor (#75N)
VdS approved.

DOOR MEASUREMENT

Dead bolt (spindled) = door thickness

Slide bolt or Swing Bolt (non-spindled) = cable length

Kaba Mas vertical and round safe locks are supplied with cable and spindles for 1" to 3-1/2" door thickness, standard. Kaba Mas offers many spindle/cable lengths to meet most safe and container requirements. Please refer to the Kaba Mas List Price Book for a complete list of options. To insure proper length, measure the door thickness where lock case is to be mounted including mounting surface or plate. Select the closest cable/spindle length greater than the total door thickness measurement.

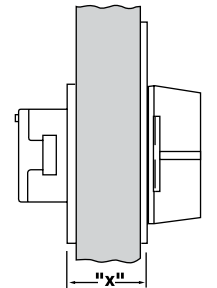

"X"=CONTAINER THICKNESS FOR LOCK MOUNTING PURPOSES

Round dead bolt example

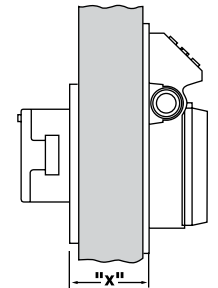

"X"=CONTAINER THICKNESS FOR LOCK MOUNTING PURPOSES

Vertical dead bolt example

ACCESSORIES

Remote Time Delay Display

This display is made of black polycarbonate with a 1-7/8" x 3/4" LCD. An integrated part of any security system that involves time delay, the Remote Time Delay Display Unit counts down the delay and counts up the open window periods. Includes display (3-7/8" x 1-7/8" x 1" box), 28" cable, angle mounting bracket and double sided adhesive. Packed 1 each. For use with T52/252/552.

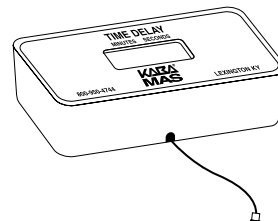

Remote Time Delay Display Unit
(p/n 307025)

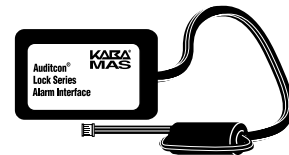

Duress Alarm Interface
(p/n 301040)

Duress Alarm Interface

2" x 1-1/4" x 1/2" black polycarbonate. Designed to send a silent signal to an external alarm system.

Universal Relocker Plate

Kit contains 20 each of the relocker plates. Plated steel designed to work with major safe manufacturer relockers.

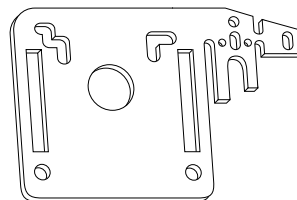

Universal Relocker Plate
(p/n 305301)

For a complete list of options, refer to the Kaba Mas List Price Book.

Auditcon 2 Series Software

**Retrieve Lock Audit and User Data for reporting at the PC • Upload Lock Setup, Users, and Time Window Data
Microsoft Windows® Compatible (XP PRO, Vista and 7 Pro) • Auditcon 2 Series Software Includes: CD-ROM,
cable, key reader, adapter (serial or USB) and Smart Key™**

DESCRIPTION

To see which users have been added and what activity has occurred at the lock, the Auditcon 2 Series Software must be utilized. You can also upload information from the PC software to the lock. Uploadable data includes lock setup options, lock users, and time windows. This function can help save time, particularly when programming several locks with similar information. All communication between the software and the lock occurs by using a programmed Smart Key. The software allows the use of a serial or USB connector with the 2-port key reader.

Compatibility

Compatible with the following Microsoft operating systems:

- Windows XP Professional (service pack 2 or greater)
- Windows Vista 32-bit or 64-bit
- Windows 7 Professional 32-bit or 64-bit

Functions

- Program Lock Setup Options: Models 252/552
- Upload Lock Time/Date: Model 552 (Teal B Smart Key required, p/n 202023 ordered separately)
- Add/Delete Users: Models 252/552 (Figure 1)
- Upload Time Windows: Model 552
- Download Audit Reports: Models 252/552 (Figure 2)
- Download User Table Reports: Models 252/552
- Compatible with previous Auditcon lock models

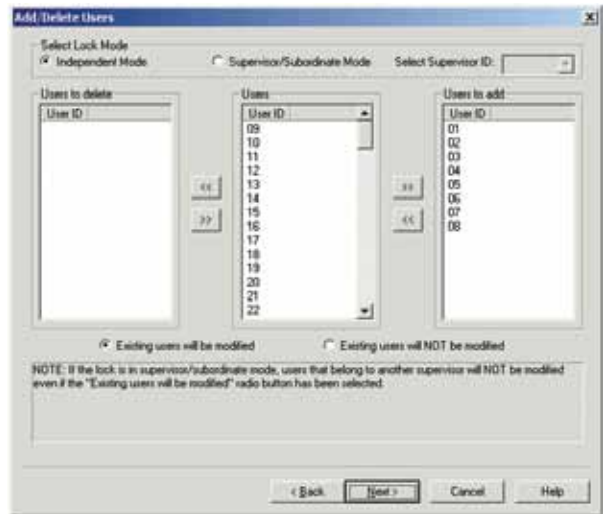

Add/Delete User example

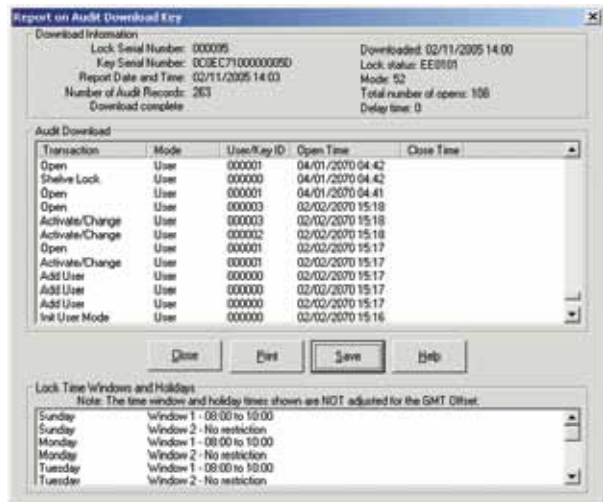

Downloaded Audit Trail example



The Kaba Safe Lock Division relies on product innovation to meet our markets' ever-changing needs for loss prevention and access control solutions.

The Kaba and LA GARD brands are synonymous worldwide with security, control and accountability.

Kaba AG | Kaba Mas | Kaba Mauer GmbH

Kaba Mas

749 W Short Street

Lexington KY 40508

phone 859-253-4744

toll-free 877-KabaMas (522-2627)

fax 859-255-2655

www.kaba-mas.com

AUDITCON2SERIES.R0611.1000